

UPM-A20-1/02

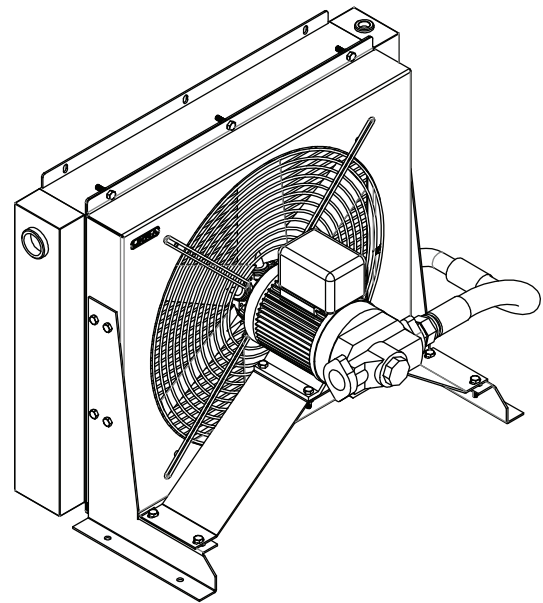
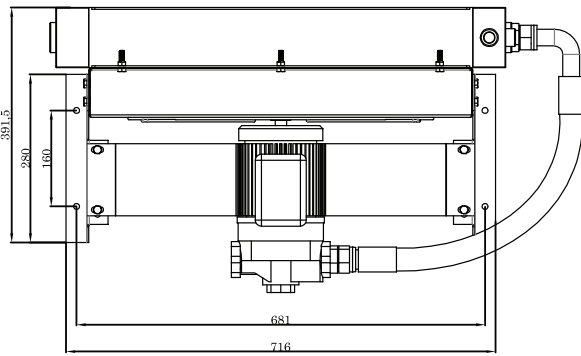
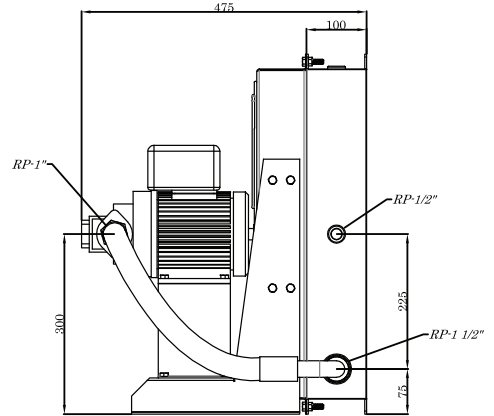
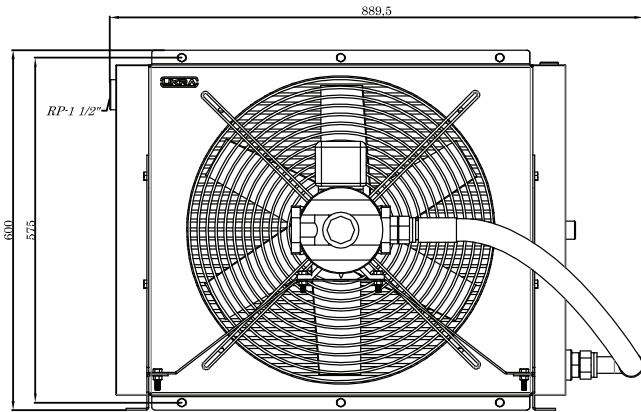

PRODUCT	OIL FLOW	MAX COOLING AT ΔT=40°C	VOLTAGE	POWER	AIR FLOW	Ø FAN	FAN SPEED	ELECTRIC PROTECTION	CAPACITY	WEIGHT
	L/min	KW	V	KW	m³/h	mm	RPM	IP	L	Kg
UPM - A20	55	25	230 - 400	1,5	7.200	500	1.500	55	14	60